



DZ2R, DZ2KR Series



- IEC connector filter with fuse or switch
R: for one or two fuses
K: with switch
- Space saving

For mini-electronic equipments and electronic measuring instruments

TECHNICAL DATA

Rated Voltage	250 VAC
Operating Frequency	50-60Hz
Rated Current	1A-10A
Test Voltage (1min)	1500 VDC (line – line) 1500 VAC (line – ground)
Climatic Category	25/085/21

Model	Terminal		Rated Current (A)	Ground Capacitance (nF)	Leakage Current ≤ (mA)	Discharge Resistance (MΩ)	Circuit Diagram fig.	Dimension fig.
	Input	Output						
DL-1DZ2R	IEC Socket	Spade Terminal	1	2.2	0.5	1	1	1
DL-3DZ2R	IEC Socket	Spade Terminal	3	2.2	0.5	1	1	1
DL-6DZ2R	IEC Socket	Spade Terminal	6	2.2	0.5	1	1	1
DL-10DZ2R	IEC Socket	Spade Terminal	10	2.2	0.5	1	1	1
DL-1DZ2KR	IEC Socket	Spade Terminal	1	2.2	0.5	1	2	2
DL-3DZ2KR	IEC Socket	Spade Terminal	3	2.2	0.5	1	2	2
DL-6DZ2KR	IEC Socket	Spade Terminal	6	2.2	0.5	1	2	2
DL-10DZRKR	IEC Socket	Spade Terminal	10	2.2	0.5	1	2	2
DL-1DZRKR2	IEC Socket	Spade Terminal	1	2.2	0.5	1	3	3
3D-Z2KR2	IEC Socket	Spade Terminal	3	2.2	0.5	1	3	3
DL-6DZ2KR2	IEC Socket	Spade Terminal	6	2.2	0.5	1	3	3
DL-10DZ2KR2	IEC Socket	Spade Terminal	10	3.3	0.5	1	3	3

TYPICAL CIRCUIT DIAGRAM

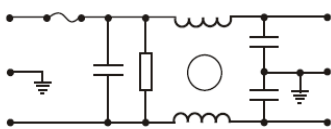

fig.1

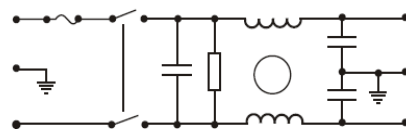

fig.2 (for one fuses)

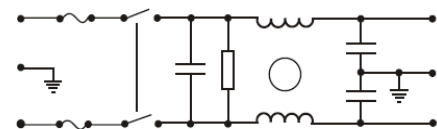
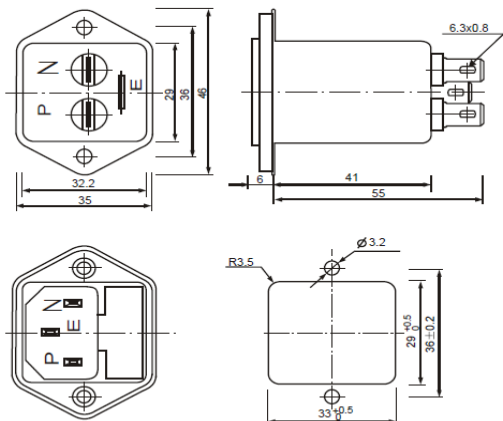

fig.3 (for two fuses)

OUTLINE DRAWING AND DIMENSIONS (mm)



Panel Cut Out
fig. 1

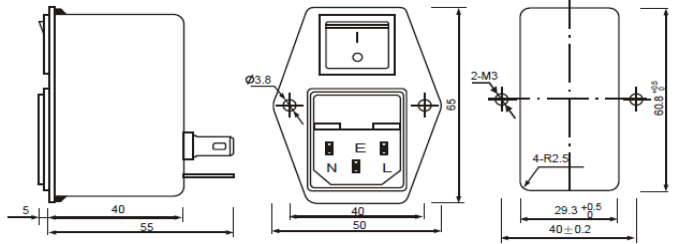

fig. 2 Panel Cut Out

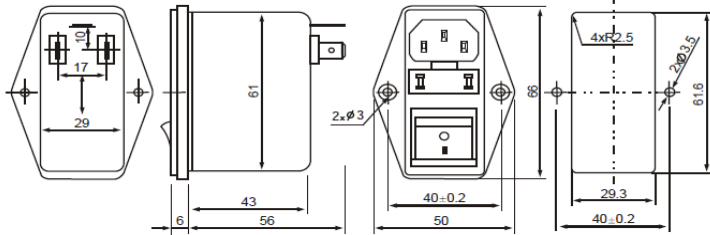
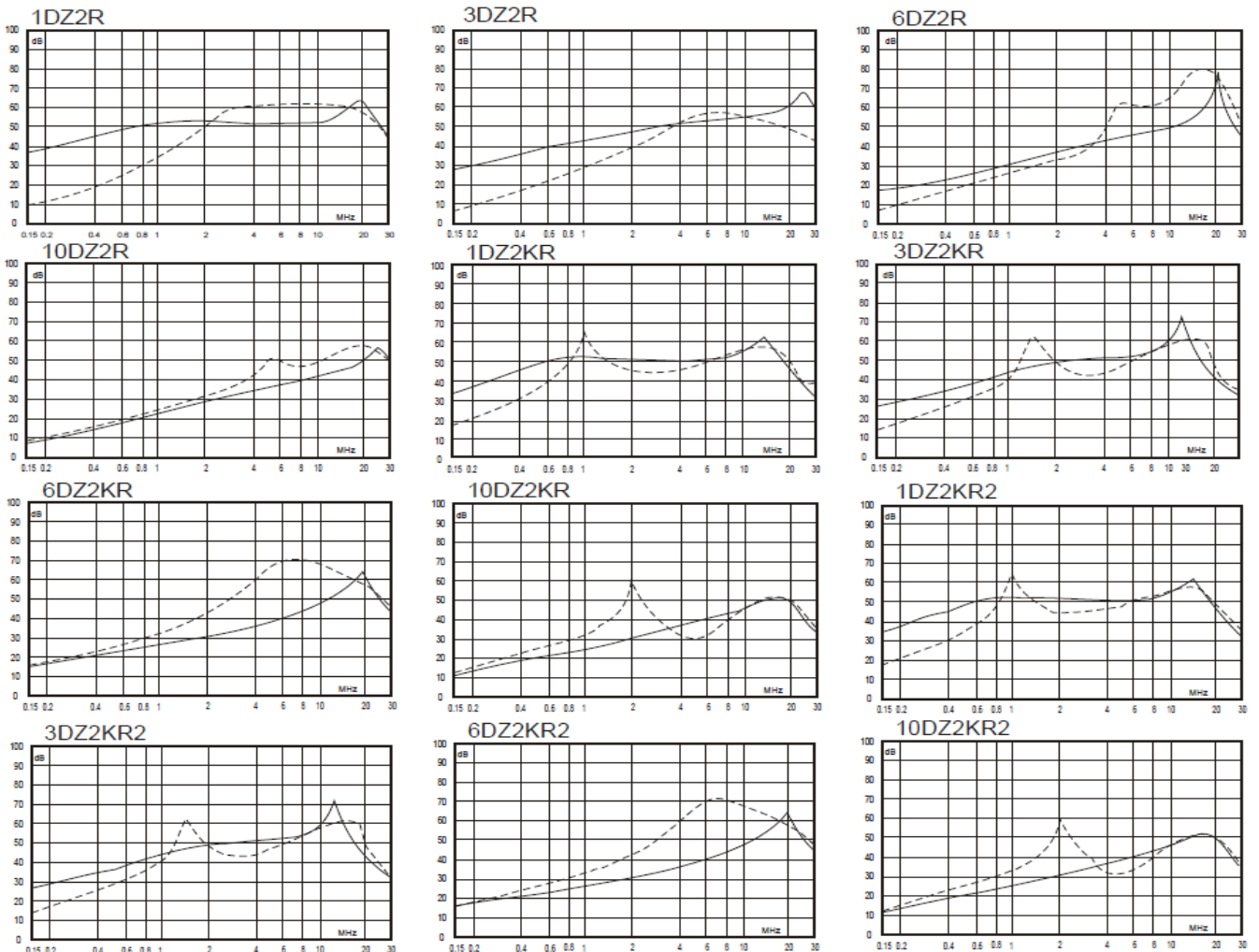

fig. 3

INSERTION LOSS

(50Ω, IEC/CISPR No 17, Measured in 50Ω system, as IEC/CISPR No. 17)



— (Common Mode)
- - - (Differential Mode)