

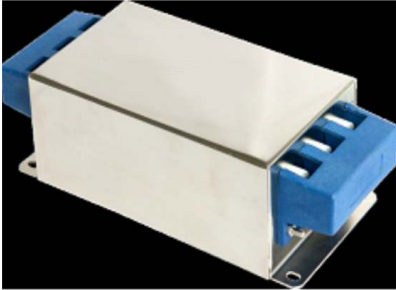

EBK6 Series



- 3-Phase EMI Power Line Filters 5 to 200A current rating
- Very compact dimensions
- Small leakage current with high attenuation for both common and differential mode
- Ideal for frequency inverters and switch mode power supplies

TECHNICAL DATA

Rated Voltage	480/275 VAC
Operating Frequency	50/60Hz
Test Voltage (1 min)	1500 VDC (line – line) 2250 VDC (line – ground)
Climatic Category	40/085/21

Filter Type	Current Ratings at 40°C (A)	Ground Capacitance Cy(nF)	Leakage Current* (440VAC/50Hz)	Circuit Diagram fig.	Dimension fig.
DL-5EBK6	5	22	<1mA	1	1
DL-10EBK6	10	22	<1mA	1	1
DL-16EBK6	16	22	<1mA	1	1
DL-20EBK6	20	50	<2mA	1	2
DL-25EBK6	25	50	<2mA	1	2
DL-35 EBK6	35	50	<2mA	1	3
DL-50 EBK6	50	50	<2mA	1	3
DL-65 EBK6	65	50	<2mA	1	3
DL-80 EBK6	80	50	<4mA	2	4
DL-100 EBK6	100	50	<4mA	2	4
DL-130 EBK6	130	50	<4mA	2	4
DL-160 EBK6	160	50	<4mA	2	4
DL-200 EBK6	200	50	<4mA	2	5

TYPICAL CIRCUIT DIAGRAM

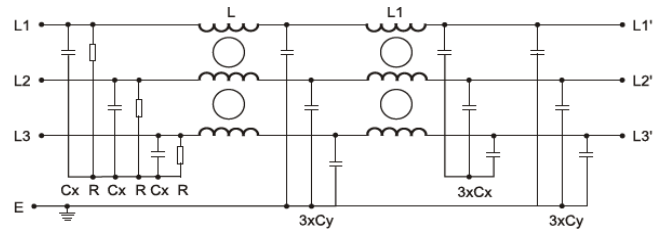
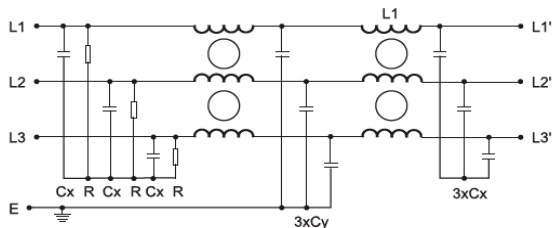

OUTLINE DRAWING AND DIMENSIONS (mm)

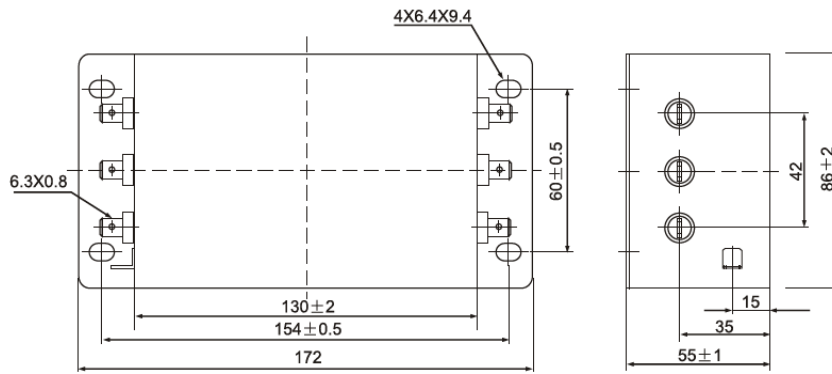

Fig.1 DL-5EBK6, 10EBK6, 16EBK6

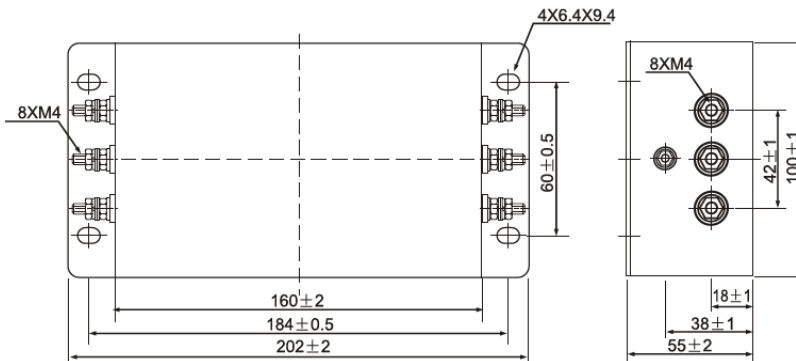

Fig.2 DL-20EBK6, 25EBK6

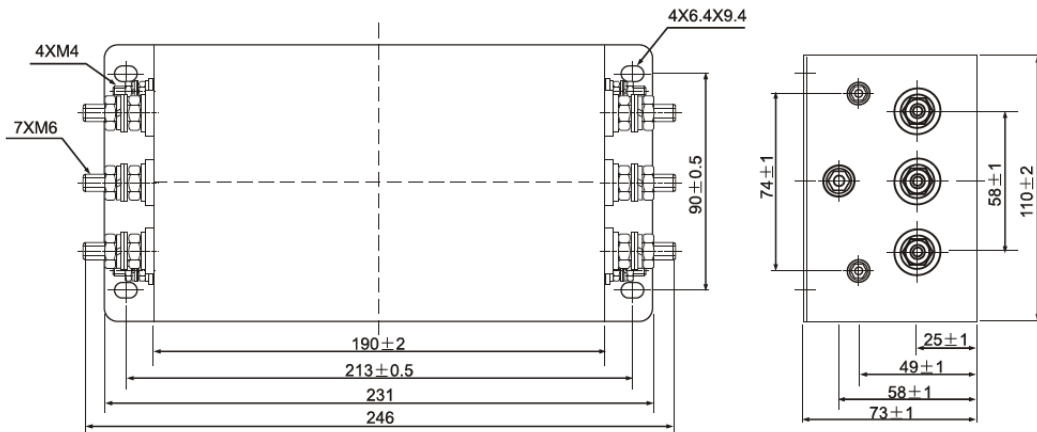

Fig.3 DL-35EBK6, 50EBK6, 65EBK6

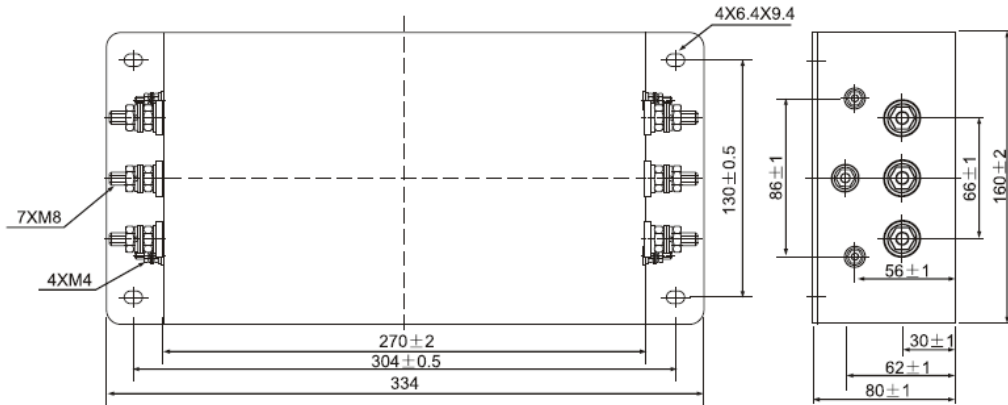

Fig.4 DL-80EBK6, 100EBK6, 130EBK6, 160EBK6

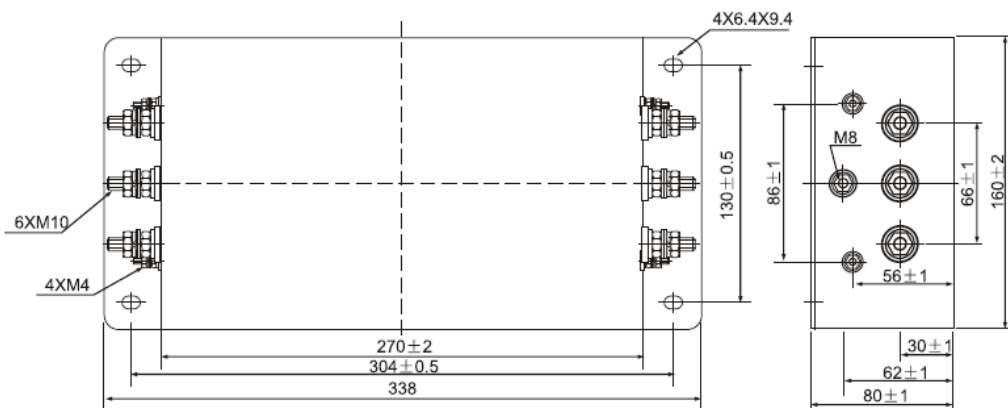
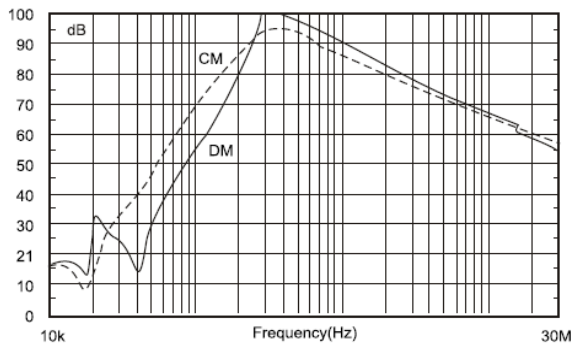

Fig.5 DL-200EBK6

INSERTION LOSS

(Measured in 50Ω system)

DL-5EBK6



DL-10EBK6

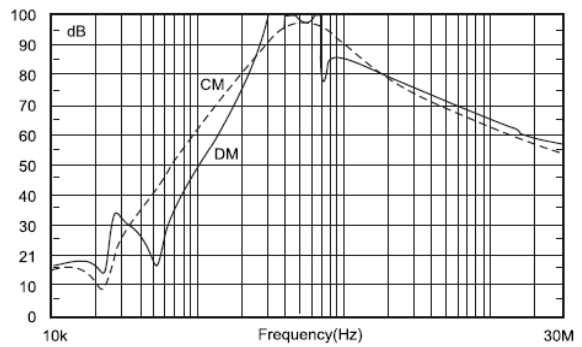

DL-16EBK6

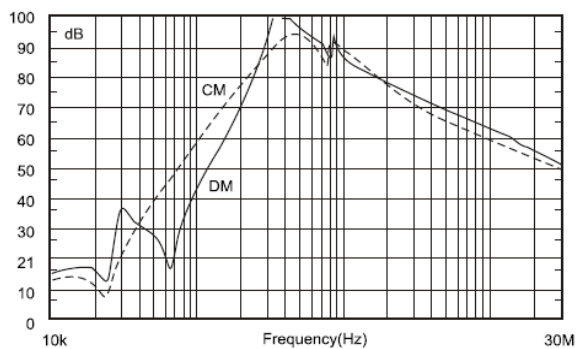

DL-20EBK6

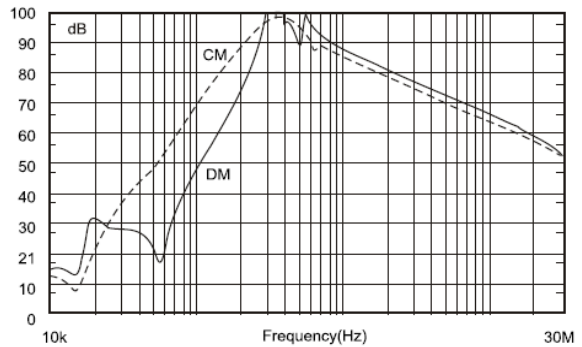

DL-25EBK6

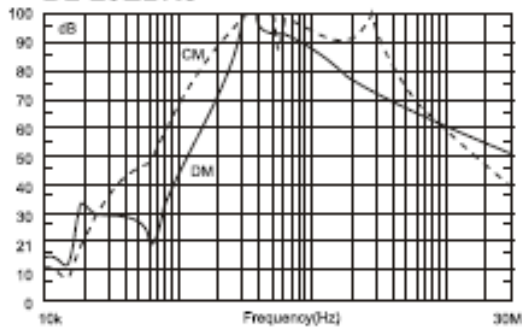

DL-35EBK6

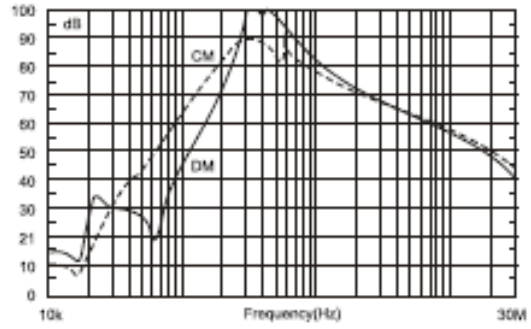

DL-50EBK6

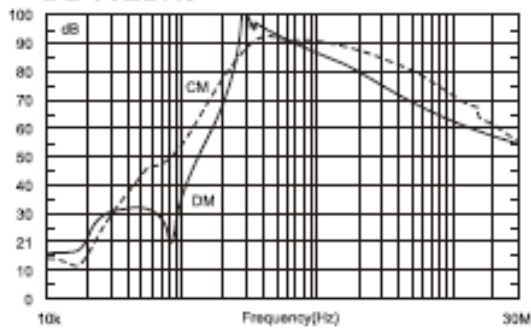

DL-65EBK6

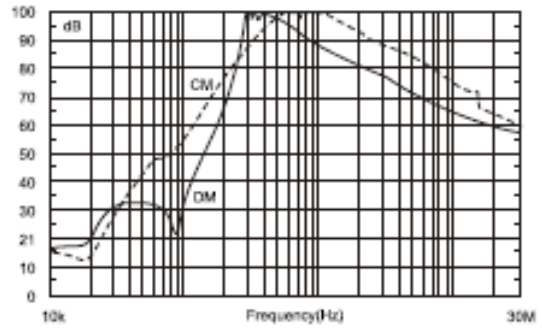

DL-80EBK6

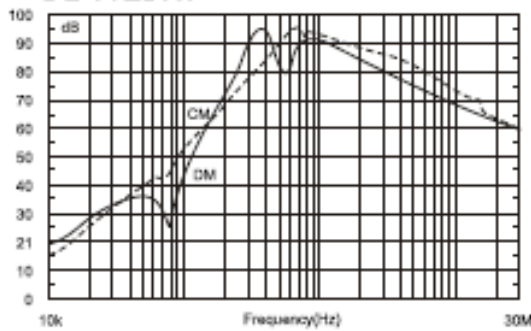

DL-100EBK6

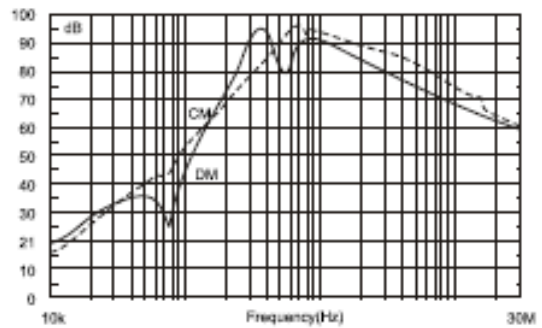

DL-130EBK6

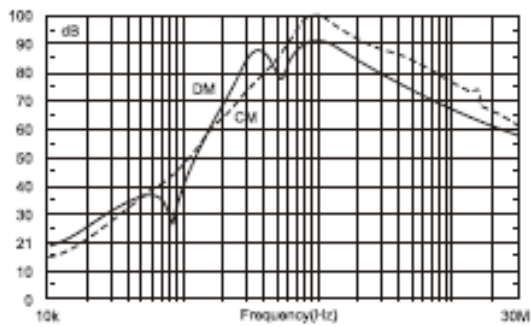

DL-160EBK6, 200EBK6

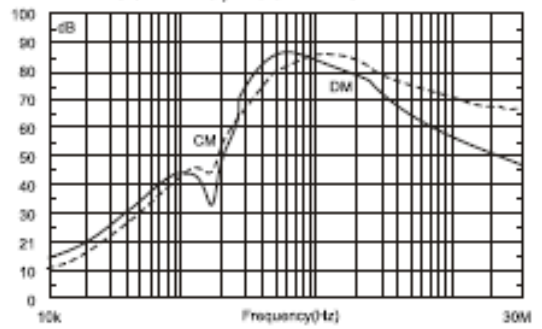

----- (Common Mode)
 ————— (Differential Mode)